

Installation

 Milling drill with \varnothing 115 mm, angle grinder or jigsaw, spirit level, marker pen, drilling machine with 6 mm bit, permanently elastic outdoor sealing

Install the wall sleeve and lay the power supply cable

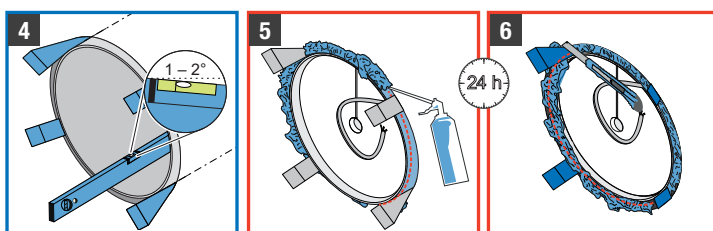
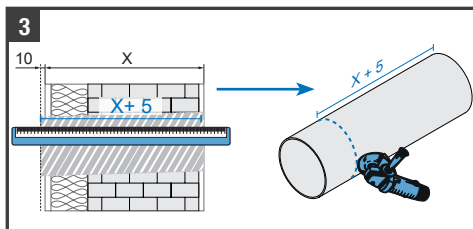
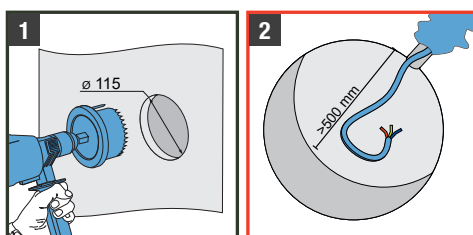
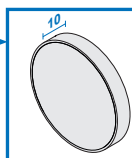

- 1 Drill a wall opening, \varnothing 115 mm, with a slope of $1 - 2^\circ$ to the exterior wall.
- 2 Lay the power connection cable, 3-wire, to the installation positions of the ventilation device.
- 3 Determine the exact wall thickness (X):
 - **Standard version:** Plaster, Masonry, Insulation, Render
 - **Corner version:** Internal structure, masonry
 Adjust the **wall sleeve** to the determined wall **thickness X+5**.
- 4 Insert the wall sleeve into the wall opening from the outside with an **overhang of 10 mm** on the exterior wall. The wall sleeve does not end flush to the interior wall. It is installed with an inner distance of 5 mm (inside the wall, see back side, Fig. 1 / Fig. 2).
 
 Fix the wall sleeve inside and outside with a slope of $1 - 2^\circ$ to the exterior wall using the mounting wedges.
- 5 Fill the gap between the wall sleeve and the masonry on the exterior and interior wall with non-pressing fitting foam.
- 6 Cut the fitting foam and protruding mounting wedges flush with the exterior and interior wall. Take care not to damage the power cable on the interior wall.

- ⚠ DANGER:** Exposed electrical components.
Electric shock and injury due to live components (230 V, 50 Hz)!
- ▶ Before working on electrical installations, disconnect all affected equipment from the power supply. Secure against being switched on again.
 - ▶ Do not lay or connect live cables.
 - ▶ Observe the requirements for protection class II when laying the mains cable.
 - ▶ Installation and connection of cables must only be performed by qualified and trained personnel.

- ! NOTICE:** Accumulation of condensate in the wall sleeve.
Interruption of the thermal insulation composite system.
Damage to exterior wall/masonry and the building structure.
- ▶ Create the wall opening with a slope of $1 - 2^\circ$ to the exterior wall.
 - ▶ Attach the wall sleeve with a slope of $1 - 2^\circ$ to the exterior wall.
 - ▶ Replace the wall construction as far as the wall sleeve.
 - ▶ Observe the necessary barrier levels.

inVENTER

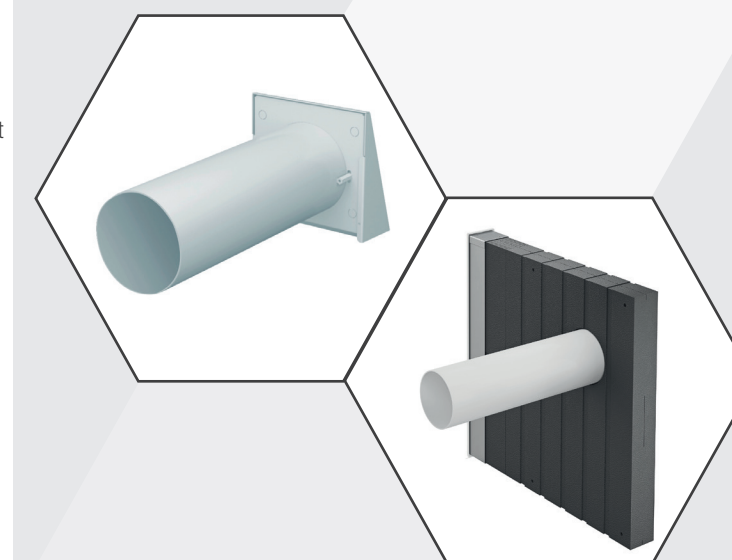

aV100 wall installation set

Instructions for use

Read before use and keep with product.

Install the exterior closure

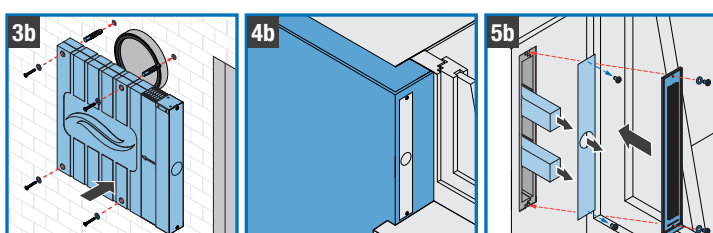
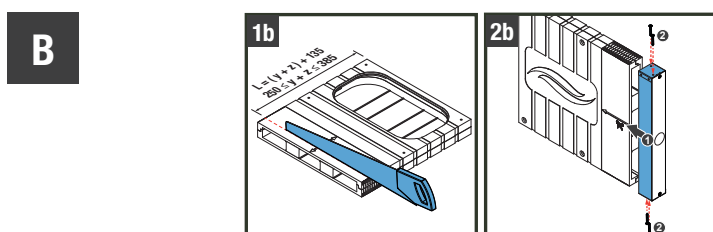
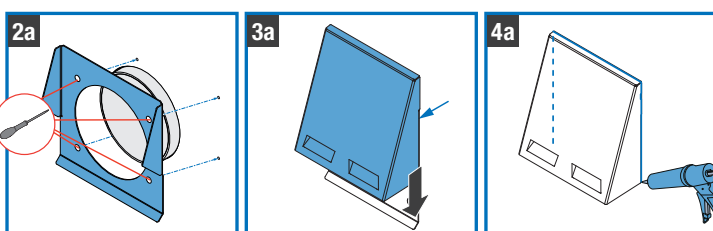
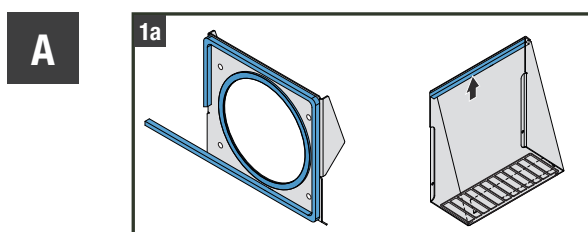

- ! NOTICE:** Penetration of condensation water and/or algae accumulation around the weather protection hood, flat duct or reveal grille may cause discolouration of the facade.
- ▶ Before and while installing the exterior closure, carry out all sealing measures (sealing tapes, outdoor sealing compound).
 - ▶ In vulnerable areas, apply a biocidal/water repellent treatment to the plaster surface around the weather protection hood before installing.

Option A: Install the aV100 weather protection hood

- 1a On the base plate's exterior wall side, attach the 9 mm sealing tape circumferentially
 - flush with the guide (7 mm clearance to outer edge).
 - flush with the opening for the wall sleeve.
 - to the top edge inside the cover.
- 2a Place the base plate onto the wall sleeve from the exterior. Level it using a spirit level. Mark the 4 drill holes. Drill the 4 holes with \varnothing 6 mm, min. 50 mm deep. Insert the rawl plugs. Screw the inner cover base plate to the exterior wall with four screws.
- 3a Place the weather protection hood cover onto the base plate from the top. The guides hook in behind the base plate. Slide the cover downwards as far as the stop.
- 4a Seal the joint between the cover of the weather protection hood and the exterior wall at the sides and top with a permanently elastic outdoor sealing compound.

- ! NOTICE:** The back-draught shutter R-D100 is already pre-assembled inside the wall sleeve. After installation, check the back-draught shutter's position: located on exterior wall side, wings aligned horizontally and closed (see fig. on the right). Correct the position if necessary.

Option B: Install the Corner flat duct and reveal grille

- ! NOTE:** For the installation of the Corner flat duct see the installation instructions „Corner“ (item no.: 5040-0023). There, the work steps are described in detail:
- 1b Shorten the flat duct to the calculated installation length
 - 2b Mounting the sliding sleeve (Push the sleeve to the stop of the protruding screw brackets.)
 - 3b Mounting the Corner flat duct (The flat duct is mounted without gradient.)
 - 4b Plastering of flat duct and sleeve
- ! NOTE:** For the installation of the reveal grille see the installation instructions „Corner reveal grille“ (item no.: 5040-0024). There, the work steps are described in detail:
- 5b Remove protective lid
Remove mounting wedges
Mounting of reveal grille

The following components are included in the **Delivery**:

- **aV100 wall installation set**, item number 1001-0159

Standard version: aV100 protective hood incl. sealing tape, Wall sleeve R-D103x495 or R-D103x745 incl. Back-draught shutter

Corner version: Corner flat duct 60x490x515 incl. sealing tape, Sliding sleeve with protective lid, Reveal grille, Wall sleeve R-D103x495 or R-D103x745 incl. Back-draught shutter

The following **extractor fans** to complete the aV100 extract air system are available from inVENTer GmbH:

- Pulsar Basic, Art.-Nummer 3002-0299
- Pulsar, item number 3002-0270
- Aviant, Art.-Nummer 3002-323
- Avio N 100, Art.-Nummer 3002-0265

inVENTer GmbH
Ortsstraße 4a
D-07751 Löberschütz
+49 36427 / 211-0
+49 36427 / 211-113
info@inventer.de

Version dated 11/2020
Revision: 4.1
Item number 5010-0008

www.inventer.eu

Subject to modifications.
We accept no liability for printing errors.
© inVENTer GmbH 1999-2020

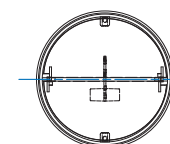

User and safety instructions

The safety and warning instructions in these instructions of use have a uniform structure and are marked with a symbol on the left side of the instruction. A signal word above the text indicates the severity of the hazard that may occur unless preventative measures are taken. If several hazard levels exist, the highest level safety instruction is always used.



DANGER: Direct danger of serious injury or death.

CAUTION: Direct danger of minor/significant injury.

NOTICE: Imminent or possible damage to property.



Tools and materials required for the task.



Graphic shows the interior wall.



Graphic shows the exterior wall.



Before performing any work on the system, read the instructions carefully and observe all information that refers to installation and cleaning. Non-observance of safety warnings could result in injury and/or property damage. Observe the relevant standards, regulations and guidelines, especially the applicable building codes and fire and accident prevention regulations issued by the respective trade association. The aV100 wall installation set is a part of the aV100 extract air system. It is completed by an extractor fan.



DANGER: Installation may only be carried out in conjunction with this documentation and by qualified personnel. When laying the power supply cable for the extractor fan, observe the requirements of protection class II. Do not lay the mains cable while it is live. Observe the installation instructions in accordance with VDE 0100 (location of extractor fan).

Product description

The aV100 wall installation set is a part of the aV100 extract air system. It is designed to ventilate rooms with external windows in single and multi-family homes, hotels and boarding houses.

The aV100 extract air system can be used in bathrooms/toilets, utility rooms, kitchens and hallways. It consists of the aV100 wall installation set and an extractor fan.

The aV100 wall installation set includes a wall sleeve (available in length 495 or 745 mm), a back-draught shutter, and an exterior closure.

On the inside the system is completed by one of the following, freely selectable extractor fans:

- Pulsar Basic extractor fan
- Pulsar extractor fan with App control
- Aviant extractor fan
- Avio N 100 extractor fan with run-on function (Humidistat optional)

Features

- Available as standard version (driving rain resistant protective hood) or corner version (flat duct and reveal grille integrated into insulating layer)
- Installation is carried out into the exterior wall, may be combined with an extractor fan in the subceiling
- Corner version is particularly suitable when subsequently fitting insulation or if a weather protection hood cannot be fitted to the outside wall for structural or other reasons (e.g. listed buildings).
- Use, if clearance between the center wall opening and window reveal is 250 to 385 mm.

Installation conditions/ Installation position/ Installation advices

- Installation of the wall sleeve is carried out in the exterior wall. The back-draught shutter is located on the exterior wall side. On the exterior the aV100 wall installation set may be completed with a weather protection hood (standard version) or a flat duct and reveal grille (corner version).
- Install the aV100 wall installation set within the air flow of the room. This will ensure optimal humidity extraction and accurate measurements of an optional sensor. Installation should be performed close to the ceiling to obtain better air distribution.

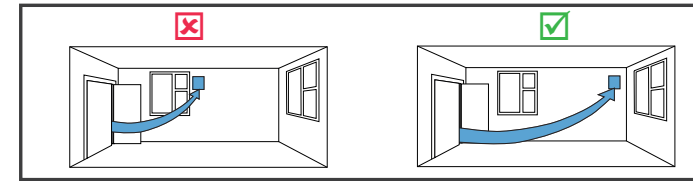

- **NOTICE:** Maintain a minimum circumferential clearance of 250 mm and a clearance of 300 mm in the front to components and walls in the vicinity. Otherwise the weather protection hood/ extractor fan may not be installed properly.

- **NOTICE:** Install the wall sleeve outside airtight and inside vapour tight into the air resistance layer. Material must be provided by the customer. (Consult your planner!)

- **NOTICE:** In order to prevent algae accumulation and a discolouration of the façade around the weather protection hood/flat duct/reveal grille observe all installation advices (apply all sealing tapes, create slope to the exterior wall!). In vulnerable areas, apply a biocidal/water repellent treatment to the plaster surface around the weather protection hood, the flat duct, and the reveal grille before installing. Consult your planner!

- **DANGER:** Ingress of water into the ventilation unit or its components/power source may cause electric shock and/or overheating due to short circuit. Observe that the extract air system must not be used in areas in which direct contact with water spray is possible when choosing an installation site [e. g. German regulation VDE 0100].

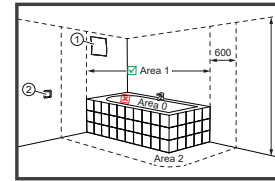

- **NOTICE:** Do not remove the protective discs from the wall sleeve during the installation process. Thus, contamination of the wall sleeve's inside is avoided.
- In order to ensure that the device does not interfere with other ventilation processes and that its functioning is not affected by them, it must always be installed in its own wall sleeve.
- The aV100 extract air system is operated with mains voltage in most use cases. 12 V DC SELV is possible in combination with Pulsar extractor fan. For the connection of the power supply unit for Pulsar extractor fan see Pulsar installation instructions.

Cleaning and maintenance

The aV100 wall installation set is virtually maintenance free. Clean the wall sleeve quarterly with a soft, damp cloth. Clean between the fins of the reveal grille and the weather protection hood using a soft brush. Any necessary cleaning or maintenance work can be carried out by the user.



DANGER: Before performing maintenance work, disconnect the extractor fan from the power supply (230 V, 50 Hz)!

Rotating parts on the extractor fan and exposed electrical components may lead to electrical shocks and personal injuries.

Construction and dimensions

aV100 wall installation set Standard version

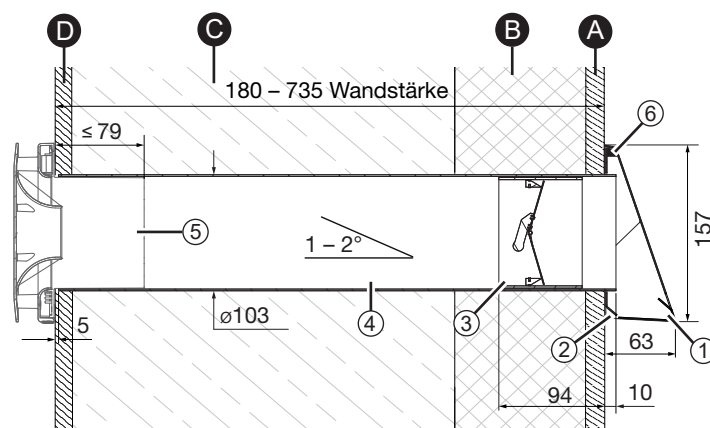

Figure 1: Sectional drawing aV100 wall installation set Standard version with Avio N 100

- A Render
- B Insulation
- C Masonry
- D Inner plaster/internal structure

- 1 Weather protection hood cover (driving rain resistant) with protective grid
- 2 Weather protection hood base plate
- 3 Back-draught shutter
- 4 Wall sleeve, L = 495 mm or 745 mm, can be shortened on site
- 5 Extractor fan (freely selectable: Pulsar Basic, Pulsar, Aviant, Avio N 100)
- 6 Sealing tape

aV100 wall installation set Corner version

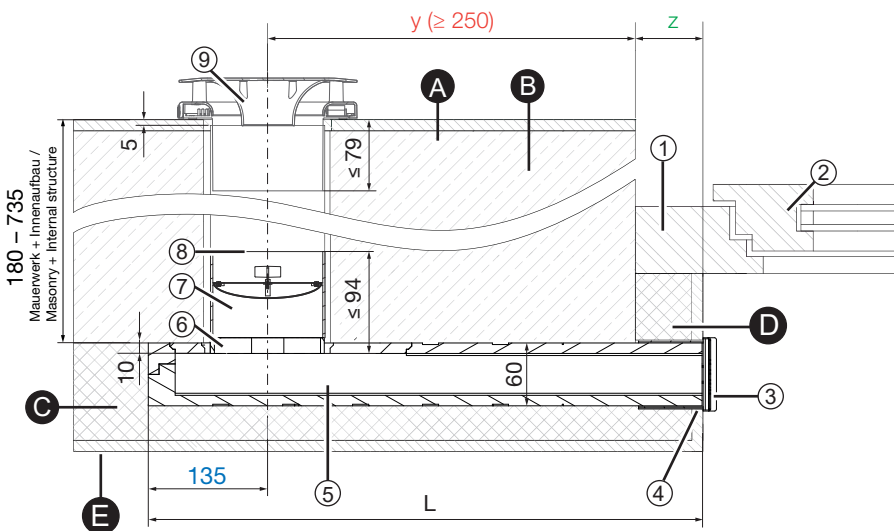

Figure 2: Sectional drawing aV100 wall installation set Corner version with Avio N 100

- A Inner plaster/internal structure
- B Masonry
- C Insulation (at least 80 mm)
- D Window reveal
- E Render

- 1 Window frame
- 2 Window casement
- 3 Reveal grille
- 4 Flat duct sliding sleeve
- 5 Corner flat duct

- 6 Sealing tape
- 7 Back-draught shutter
- 8 Wall sleeve, L = 495 mm or 745 mm, can be shortened on site
- 9 Extractor fan (freely selectable: Pulsar Basic, Pulsar, Aviant, Avio N 100)

Installation length of the flat duct::

$$L_{\text{installation}} = (y + z) + 135 \text{ mm}$$

$$250 \leq (y + z) < 385$$

Specifications

Feature	Value	
	Standard	Corner
Operating range [°C]	-20 – 50	
Wall thickness [mm]	180 – 745	min. 180; Thickness of masonry + internal structure [mm]: max. 745
Wall sleeve [ø, L in mm]	ø 100, 495/745	
Wall opening exterior wall [mm]	ø 115	
Wall opening subceiling [mm]	ø 105	
Material/colour of wall sleeve	ABS/ white	
Exterior closure [W x H x D in mm]	154 x 157 x 63	Corner flat duct: 60 x 515 x 490 Reveal grille: 70 x 512 x 12,4
Material/colour of reveal grille	white – RAL 9016 grey – RAL 9006 Nord – RAL 7011 Anthrazit – RAL 7016	white – RAL 9016 grey – RAL 9006 Anthrazit – RAL 7016