



# INVENTER

Installation and operation instructions

## Pulsar



### Extractor fan



[www.inventer.eu](http://www.inventer.eu)

## Trademarks, copyrights and property rights

inVENTer® is a protected trademark of inVENTer GmbH.

The copyright to this document remains with the manufacturer. Rights to all content and images:

© inVENTer GmbH 2022.

All trademarks used in this document are the property of their respective manufacturers and hereby acknowledged.

## Disclaimer

This documentation represents a translation of the original german installation and operation instructions.

After completion of the installation the information regarding access to these installation instructions must be handed over to the user (tenant, owner, property management; etc).

The contents of this documentation have been checked for conformity with the hardware and software described. Nevertheless, deviations cannot be excluded, so that no guarantee can be given for complete conformity.

This documentation describes the functionality of the standard scope. For reasons of clarity, the documentation does not purport to cover all details on all types of the product and cannot cover every conceivable scenario for installation, assembly, operation, cleaning and maintenance. The illustrations in this documentation may differ slightly from the design of the product that you have purchased. The same functionality is ensured despite any design deviations.

This documentation is updated regularly. Necessary corrections and expedient additions are always included in subsequent editions. You can find the latest version at **[www.inventer.eu/downloads](http://www.inventer.eu/downloads)**.

## Company Information

Publisher:

inVENTer GmbH	Phone: +49 (0) 36427 211-0
Ortsstraße 4a	Fax: +49 (0) 36427 211-113
D-07751 Löberschütz	E-Mail: <a href="mailto:info@inventer.de">info@inventer.de</a>
Germany	Web: <a href="http://www.inventer.eu">www.inventer.eu</a>

CEO: Annett Wettig  
VAT Number: DE 815494982  
Jena District Court HRB 510380

## Table of contents

<b>1 User- und Safety instructions</b> .....	<b>4</b>	<b>7 Operation</b> .....	<b>22</b>
1.1 User information .....	4	7.1 Functional scope.....	22
1.2 Safety instructions .....	4	7.2 LED-display .....	23
<b>2 System overview</b> .....	<b>6</b>	<b>8 Cleaning and care</b> .....	<b>23</b>
2.1 Function .....	7	<b>9 Technical Data</b> .....	<b>25</b>
<b>3 Preparing for installation</b> .....	<b>8</b>	<b>10 Scope of supply</b> .....	<b>26</b>
3.1 Mounting conditions.....	8	<b>11 Accesories</b> .....	<b>26</b>
3.2 Dimensions .....	9	<b>12 Service</b> .....	<b>26</b>
3.3 Dimensional drawings.....	9	<b>13 Warranty und guarantee</b> .....	<b>26</b>
<b>4 Electrical connection</b> .....	<b>9</b>	PIN-code/serial number .....	28
4.1 Electrical connection AC 230 V.....	10		
4.2 Electrical connection DC 12 V .....	12		
<b>5 Installation</b> .....	<b>14</b>		
5.1 Fit the wall sleeve and route cables.....	14		
5.2 Mount power supply unit (optional).....	15		
5.3 Insert and connect the Pulsar .....	16		
<b>6 Commisioning</b> .....	<b>21</b>		

## 1 User and safety instructions

Thank you for purchasing this high quality product from inVENTer!

This section provides an overview of the basic safety precautions for safe and proper operation of your ventilation system.

### 1.1 User information

#### Safety and warning instructions

The safety and warning instructions in these installation instructions have a uniform structure and are marked with a symbol on the left side of the instruction. A signal word in front of the text also indicates the hazard level. If several hazard levels exist, the highest level safety instruction is always used.



#### SIGNAL WORD

##### Type and origin of the hazard.

Possible consequences of the hazard!

- Measures to avoid the hazard.

The signal word indicates the severity of the potential hazard unless preventive measures are taken:



**DANGER** means: Imminent danger of serious injury or death.



**WARNING** means: Possible danger of serious injury.



**CAUTION** means: Direct danger or minor/significant injury.



**NOTICE** means: Direct or possible risk of property damage due to an adverse event/state.

#### Other symbols used in this documentation



A **TIP** symbol indicates practical and useful tips for handling your extractor fan.



Before each step, any additional tools and materials required for the activity are listed.



**Action required:** prompts the user to perform specific actions.



**Check the results:** requires user to check the results of the action performed.

All graphics represent the interior wall.

### 1.2 Safety instructions



The installation instructions are part of your ventilation device and must be available at all times (see [www.inventer.eu/downloads](http://www.inventer.eu/downloads)). When handing the system to a third party, the information regarding access to the installation instructions must be handed over also. Before performing any work on the device/system, read this documentation carefully and observe all the instructions for installation, commissioning and maintenance given in this section. In addition, observe the safety instructions that precede the described handling instructions.

Non-observance of safety instructions could result in injury and/or property damage.

## Intended use

The Pulsar extractor fan (hereinafter referred to as “Pulsar”) is used to ventilate rooms with external windows, taking into account the technical data and applications described in this manual, and only in conjunction with the components recommended by inVENTer GmbH and which are mentioned in this documentation.

Modifications or conversions to the appliance are not permitted. The Pulsar complies with the technical safety requirements and standards for electrical appliances for domestic use. It may only be set up and operated in conjunction with this documentation.

Proper transport, storage and installation as well as careful operation and maintenance are prerequisites for the faultless and safe operation of the appliance.

- Always observe the relevant standards, regulations and guidelines when installing the equipment/system.
- The Pulsar is designed for permanent installation with permanent wiring.
- **CAUTION: The appliance may only be installed by qualified personnel.**
  - Comply with the specifications of protection class II when laying the mains cable.
  - Wire all the units in a ventilation system to the the same circuit breaker.
  - Only lay and connect cables when they are disconnected from the power supply!
  - It must be ensured that the mains power supply (voltage, frequency) corresponds to the specifications on the type plate.
  - Before working on electrical installations, disconnect all relevant devices from the power supply.
  - Before drilling, check whether there are any there are cables in the drilling area.
- **DANGER:** Observe the installation regulations according to VDE 0100 when connecting in damp rooms.
  - Attach the Pulsar solely outside the protected area 0. (📖 Chapter 3.1, Page 8).
  - Do not use the Pulsar in places where direct contact with splashing water is possible over a long period of time and/or where the unit is exposed to direct jets of water
- **WARNING:** For the joint operation of a ventilation device with fireplaces, safety measures must be taken to prevent the development of negative pressure in the building. The decision as to which measures should be implemented is made by the responsible chimney sweep and/or building planner.
- **CAUTION:** The appliance must not be operated by children and/or persons who, because of their physical, sensory or mental capabilities or inexperience or lack of knowledge, are not capable of doing so safely. Young children must be supervised to ensure that they do not play with the appliance.
- **NOTICE:** Using too small a wire cross-section leads to too high a voltage drop and/or contacting is not guaranteed!
- **NOTICE:** Ensure sufficient contacting of the lines when connecting the Pulsar.
- **NOTICE:** Lay cables without a plaster-resistant cable sheath in the empty conduit to avoid short circuits and/or cable fires.
- **NOTICE:** The device has plastic surfaces that are sensitive to scratches. Do not touch components with oily and/or dirty hands. Avoid contact with sharp or pointed objects.
- Ensure sufficient air supply in the room, for example by a large gap under the door
- The exhaust air fan may only be put into operation after completion of the construction work.

If your device has a defect, contact your factory representative or our technical service.

### Improper Use

Use contrary to the intended purpose leads to the exclusion of any liability claims. Any use that is not mentioned in the chapter intended use is considered improper use.

In particular, do not install/operate the device in areas where the following may occur:

- Environment containing strong oils or lubricants.
- Flammable, aggressive and corrosive gases, liquids or vapours.
- Ambient temperatures outside the range of 5 – 50 °C
- Possible obstacles preventing access or the removal of the fan.

### Qualified personnel

Installation and electrical connection of the unit may only be carried out by qualified personnel (see also icon ).

Qualified personnel in the sense of the safety instructions in this documentation are persons who are authorised to install, commission and label devices, systems and circuits in accordance with the standards of safety technology.

### Conformity

The Pulsar meets the requirements for mechanical safety (DIN EN 60335-2-80).

The Pulsar is equipped with a Bluetooth radio system.

**Bluetooth LE: -12dBm EIRP (63µW), nominal 2450 MHz.**

inVENTer GmbH hereby declares that the Bluetooth radio system installed in the device complies with Directive 2014/53/EU. The full text of the EU Declaration of Conformity is available at the following internet address:  
<https://www.inventer.eu/downloads/>

## 2 System overview

The Pulsar is an innovative extractor fan with a contemporary design. It improves the basic ventilation in your rooms and enables continuous ventilation to reduce humidity and odours in wet rooms (WC/bathroom/shower room/laundry room).

Additionally, the Pulsar can be used as an overflow fan.

The Pulsar can be used in conjunction with the aV100 wall mounting set or installed in another wall mounting sleeve with a diameter of 100 ... 140 mm (non-return valve must be retrofitted on site in this case).

Installation is possible in ceilings and exterior walls. If the Pulsar extractor fan is used as an overflow fan, it can also be installed in interior walls. The Pulsar allows connection directly to the 230 V mains or connection via a power supply unit. Please note that not all functions are available when connecting to DC 12 V.

To ensure that the Pulsar does not interfere with other ventilation units/devices and that its function is not interfered with by other ventilation operations, it must always be installed in its own wall sleeve. There must be no obstacles or other objects in this sleeve that could interfere with the airflow. In order to avoid any condensation from forming in wall sleeves (in winter), they must be insulated at the points where they run through unheated areas, such as cold attics.

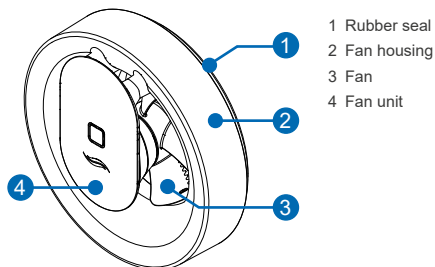

Figure 1: Pulsar extractor fan

## 2.1 Function

The Pulsar extractor fan is programmed to suit most installations.

The following factory settings are pre-programmed:

- Automatic control by light exposure:  
When the lighting conditions change, lights are switched on, shadows change or when a person enters the room, the fan starts with an air flow rate of about 60 m<sup>3</sup>/h and runs for 15 minutes. After that, the Pulsar switches off again.
- Automatic humidity monitoring:  
If the air humidity rises sharply, for example when the shower is used, the air flow rate increases to a maximum of 95 m<sup>3</sup>/h. When the humidity has been reduced, the Pulsar switches off again.

When the Pulsar is switched on for the first time, the factory settings are active.

Further control and set-up of the Pulsar is done using the inVENTer Mobile application software.

If required, the Pulsar can also be used as an overflow fan for ventilating and heating neighbouring rooms without heating facilities. The Pulsar switches on when the selected temperature limit is exceeded. It switches off again when the temperature in the room falls below the selected limit value.

The extractor fan is controlled and set up using the inVENTer Mobile App.

The App can be downloaded for free in Google Play Store (Android) or in the App Store (iOS).



## Technical Requirements:

- Mobile devices with Android or iOS operating system
- Bluetooth LE

The following additional settings and functions can be changed via the inVENTer Mobile App:

- Air flow volume adjustment
- Humidity sensor sensitivity
- Light sensor sensitivity
- Run-on function
- Switch-on delay
- Boost function
- Intelligent pause function
- Interval operation
- Continuous ventilation settings
- Temperature settings when used as overflow fan

### 3 Preparing for installation

#### 3.1 Mounting conditions

##### Electrical protection areas according to VDE 0100



#### **DANGER**

**Infiltration of water into the Pulsar extractor fan or its power source.**

Electric shock and overheating through short circuit (230V, 50 Hz)!

- Install the Pulsar outside the protection area 0.
- Only install the Pulsar in areas of protection zone 1 where direct contact with splash water is **not** possible over a long period of time and/or the unit is **not exposed to direct jets of water**.
- Fit lightswitch/ switch/ push-button outside the protected area 0 to 2.

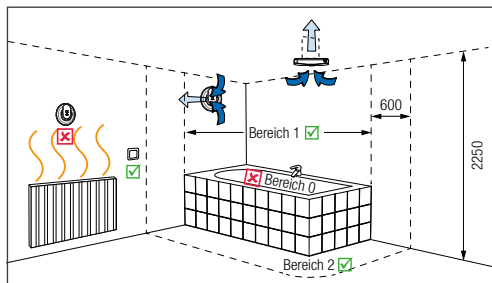

Figure 2: Overview of electrical safe areas in the bathroom

##### Positioning of the Pulsar

- Install the Pulsar extractor fan in the room's air flow to ensure optimum moisture removal and reliable readings from the humidity sensor.

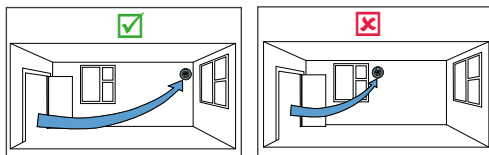

Figure 3: Proper/improper positioning

- Do not place the ventilation device over heating units, room thermostats and/or delicate furniture.
- Ensure there is sufficient air supply in the room, for example by a large gap under the door

##### Cable cross-sections

- Supply line, AC 230 V, 50 Hz:  
Wire cross-section 1,5 mm<sup>2</sup>
- Operating voltage to the extractor fan, DC 12 V,  
Wire cross-section max. 1,5 mm<sup>2</sup>
- Capacity of connection terminals on the exhaust air unit:  
max. 1,5 mm<sup>2</sup>



### 3.2 Dimensions



Keep a minimum distance of 250 mm from components at the front and all around.

Description	Depth/ Length [mm]	Ø [mm]
Drill holes wall openings:		
Wall mounting sleeve <sup>1)</sup>	Wall thickness	115
Suspended ceiling	Wall thickness	105
Flush-mounted box PSU <sup>1)</sup>	66	68
Cavity wall box PSU <sup>1)</sup>	61	68
Mounting elements:		
Pulsar extractor fan	81	177
Wall sleeve DN 100 <sup>1)</sup>	Wall thickness	100
PSU <sup>2)</sup> (DC 12 V)	32	54

<sup>1)</sup> Wall mounting sleeves are available in the aV100 wall mounting set, including weather protection cover, from inVENTer GmbH.

## 4 Electrical connection

The Pulsar extractor fan can be connected directly to the AC 230 V mains or operated safely with extra-low voltage 12 V DC (SELV). A power supply unit (PSU) is optionally available.



**NOTICE: If 230 V AC and 12 V DC are connected at the same time,** the Pulsar extractor fan will be damaged!

- **Never connect** the Pulsar extractor fan **simultaneously** to 230 V AC and 12 V DC.



**NOTICE: Laying the mains cable over the cover of the circuit board** will damage the board and impair the function of the Pulsar!

- Do not lay the AC 230V mains cable over the circuit board.

### 3.3 Dimensional drawings

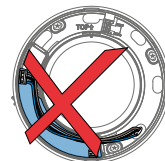
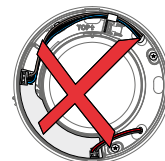
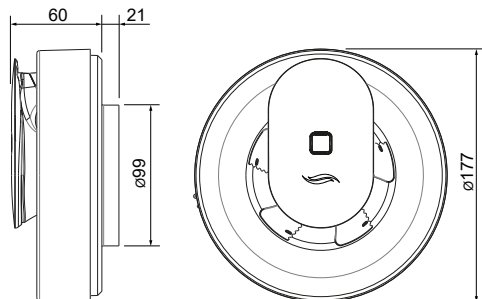

## 4.1 Electrical connection 230 V AC (Alternating current)

### Connection terminal for mains connection cable

Terminal assignment

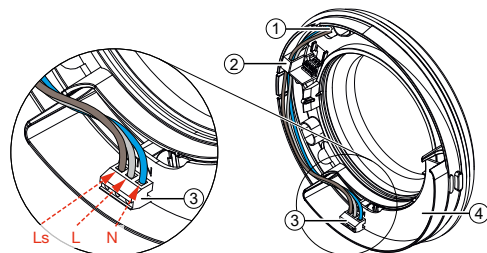

- 1 Cable input for mains connection cable
- 2 Cable feed-through for mains connection cable
- 3 Connection terminal mains connection cable, 230 V AC, 3-pole

Terminal	Labelling	Meaning
N	N	Neutral conductor
L	L	Phase conductor
LS	T	Phase switch

- 4 Circuit board

Figure 4: Circuit board – Connection terminal: mains connection cable 230 V AC

### Wiring diagrams 230 V connection

The connection of the extractor fan depends on the desired functions. Make sure that you connect the extractor fan correctly and select the correct presets for your functions during commissioning.

#### Sensor-controlled, with continuous ventilation:

- Setting must be selected via the inVENTer Mobile App.
- Continuous ventilation with an air flow volume of 30 m<sup>3</sup>/h.
- Increased fan power when activated by the integrated humidity or light sensor.

#### Sensor-controlled, without continuous ventilation:

- Factory setting (on-demand controlled ventilation).
- The Pulsar switches on and off automatically when activated by the integrated humidity or light sensor.

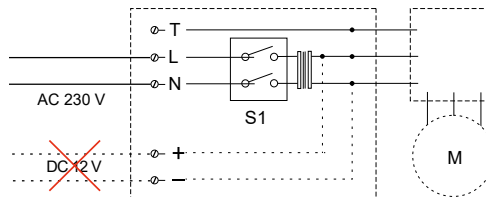

Figure 5: Pulsar 230 V AC with active sensors

**Use as an overflow fan:**

- Setting must be selected via the inVENTer Mobile App.
- Suitable for ventilation of adjacent rooms.
- The Pulsar is switched on and off based on temperature; the light and humidity sensors are inactive.

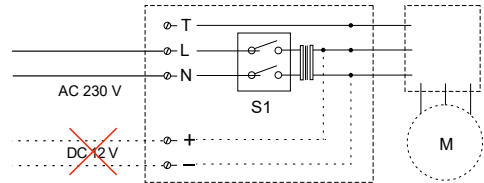

Figure 6: Pulsar 230 V AC as overflow fan

**Switch-controlled functions****Switch-controlled, without run-on function:**

- Setting must be selected via the inVENTer Mobile App.
- The extractor fan is switched on and off via a manual, external switch S.
- Sensors are disabled.
- After switching off the fan at the external switch S, the fan switches off immediately.

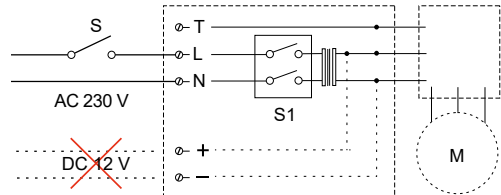

Figure 7: Pulsar 230 V AC, switch-controlled, without run-on function

**Switch-controlled, with run-on function:**

- Setting must be selected via the inVENTer Mobile App.
- The extractor fan is switched on and off via a manual, external switch S.
- Sensors are disabled.
- After switching off the fan at switch S, the fan continues to run for the set run-on time and then switches off automatically.

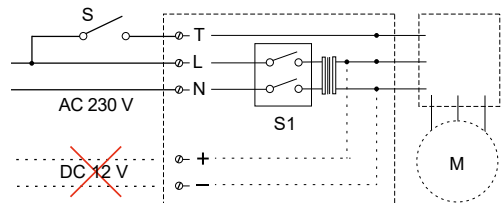
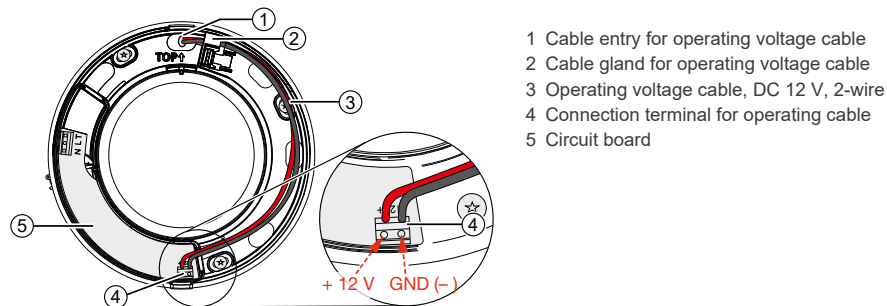

Figure 8: Pulsar 230 V AC, switch-controlled, with run-on function

## 4.2 Electrical connection 12 V DC (Direct current)

### Connection terminal for operating voltage cable

Terminal assignment



- 1 Cable entry for operating voltage cable
- 2 Cable gland for operating voltage cable
- 3 Operating voltage cable, DC 12 V, 2-wire
- 4 Connection terminal for operating cable
- 5 Circuit board

Figure 9: Circuit board – Connection terminal 12 V DC

### Wiring diagrams 12 V connection

The connection of the exhaust fan depends on the desired functions. Make sure to connect the exhaust air fan correctly and select the correct presettings for your functions during commissioning. The switch S1 integrated on the exhaust fan Pulsar has no function when connecting 12 V DC.

### Sensor controlled functions

#### Sensor-controlled, with continuous ventilation:

- Setting must be selected via the inVENTer Mobile App.
- Continuous ventilation with an air volume flow of 30 m<sup>3</sup>/h.
- Fan power increases in case of increased humidity or under the influence of light changes.

#### Sensor-controlled, without continuous ventilation:

- Factory settings to ensure ventilation as required.
- The extractor fan is switched on and off automatically when there is a change in humidity or when there is a change in light.

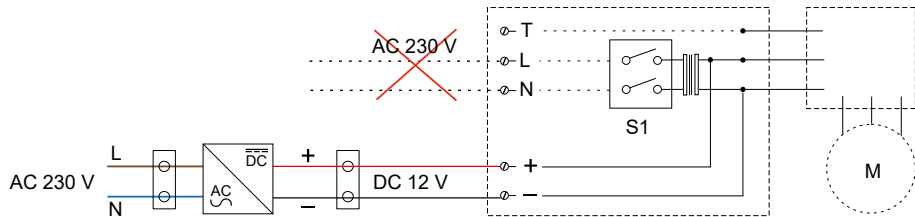

Figure 10: Wiring diagram for NT16 flush-mounted power supply unit and Pulsar extractor fan 12 V DC (sensor-controlled and use as overflow fan)

#### Usage as overflow fan:

- Setting must be selected via the inVENTer Mobile App.
- Suitable for ventilating adjacent rooms.
- The extractor fan is switched on and off based on temperature; the light and humidity sensors are inactive.

#### Switch controlled functions

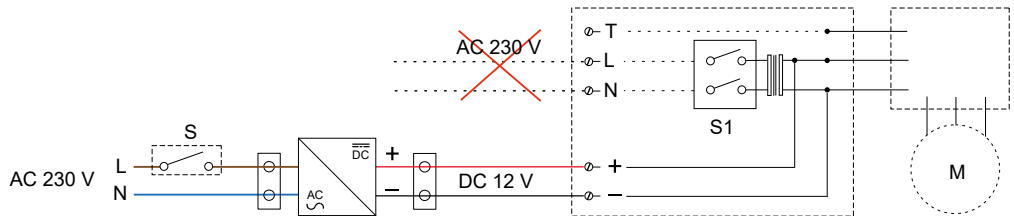

Figure 11: Wiring diagram for NT16 flush-mounted power supply unit and Pulsar extractor fan DC 12 V (switch-controlled)

#### Switch-controlled, without run-on function:

- Setting must be selected via the inVENTer Mobile App.
- The Pulsar is switched on and off via a manual external switch S.
- The sensors are deactivated.

## 5 Installation



### **DANGER: Exposed electrical components.**

Electric shock and injury due to live components (230 V, 50 Hz)!

- Connection only by qualified personnel.
- Observe the safety rules for avoiding electrical accidents before and during installation.



### **DANGER: Water ingress into the extractor fan or its components/power source.**

Electric shock and overheating through short circuit (230V, 50 Hz)!

- Mount Pulsar extractor fan outside the protection area 0 according to VDE 0100.
- Only install the Pulsar in areas of protection zone 1 where direct contact with splash water is not possible over a longer period of time and/or the unit is **not exposed to direct jets of water**.
- Fit light switch/switch/button outside protection zone 0 to 2.

### 5.1 Mount wall sleeve and route cables



Milling drill  $\varnothing$  115 mm, wall sleeve  
(e.g. aV100 wall mounting set)

Requirements:

- The masonry is dry and load-bearing.
- There are no load-bearing elements in the position of the planned drill hole/plaster or wall slot.

► At Pulsar's installation site, create a wall opening of  $\varnothing$  115 mm.

► Mill the plaster/masonry slot between the power source/switch and mounting location of Pulsar.



For possibilities of positioning the cable gland, see figure 12. The cable gland should be located near the respective connection terminal.

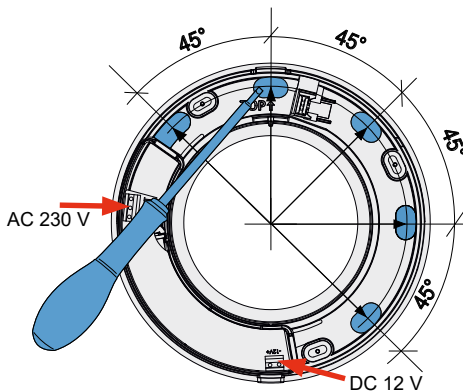

Figure 12: Cable entry options



**NOTICE: Accumulation of condensation water in the wall sleeve** leads to damage to the outer wall masonry!

- Insert the wall sleeve with a slope of 1 – 2° to the exterior wall side.

▶ Mount the aV100 wall mounting set  
(📖 Assembly instructions aV100 wall mounting set).

**OR**

▶ Insert a DN100 wall sleeve into the wall opening.



• The wall sleeve does not end flush with the plaster on the inside wall. It is installed with a distance of 5 mm to the inside (into the wall).



• An appropriate non-return valve must be provided and fitted by the customer.

The aV100 wall mounting set (wall sleeve incl. non-return valve and external termination), which serves as a receptacle for the Pulsar extractor fan, and is optionally available from inVENTer GmbH.

## Routing cables

▶ Route the mains connection cable, 3-wire:

- from the control cabinet to the installation location of the Pulsar, **or**
- between the external switch/button and the installation location of the Pulsar.



The cable end protrudes approx. 300 mm from the wall.

▶ Mount the power supply unit (📖 5.2, optional).

⇒ The wall sleeve is mounted.

## 5.2 Mount the power supply unit (optional)

The installation of the additional power supply unit is only carried out with the Electrical connection 12 V DC. A power supply unit and a mounting box can be ordered as optional accessory.



Milling drill  $\varnothing$  68 mm, connecting clamps, filler material for plastering the box

- ▶ Create a wall opening for the mounting box at the mounting location of the power supply unit.
- ▶ Route the necessary cables to connect the power supply unit to the mounting location:
  - Supply line between control cabinet and mounting location Power supply: AC 230 V, 50 Hz
  - Operating voltage to the exhaust air unit: DC 12 V
- ▶ Route the cables at the mounting location of the power supply unit in the mounting box.
- ▶ Install the mounting box on the inside wall.

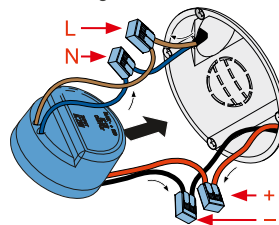

- ▶ Connect the power supply unit using the connection terminals:
  - Connect the mains cable, AC 230 V, to the input lines (blue, N / brown, L);
  - Connect the operating voltage cable, DC 12 V, to the output lines (red, + / black, -).
- ▶ Slide the power supply unit into the mounting box.
- ▶ Cover the mounting box, e.g. with a blind cover.

### 5.3 Insert and connect the Pulsar



Screwdriver, drill, dowels, screws, spirit level, stripping tool

Requirements:

- The wall sleeve is mounted. styrofoam discs have been removed.
- The connection cable (AC 230 V, 50 Hz/ DC 12 V) has been laid.

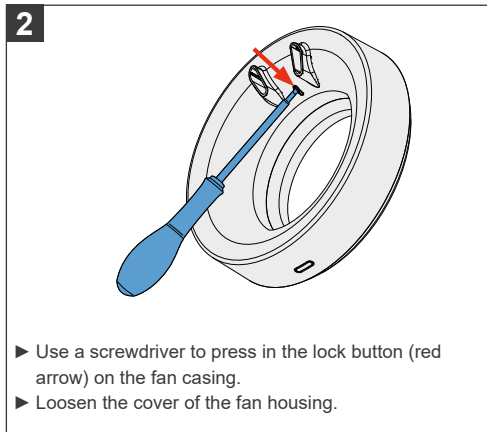
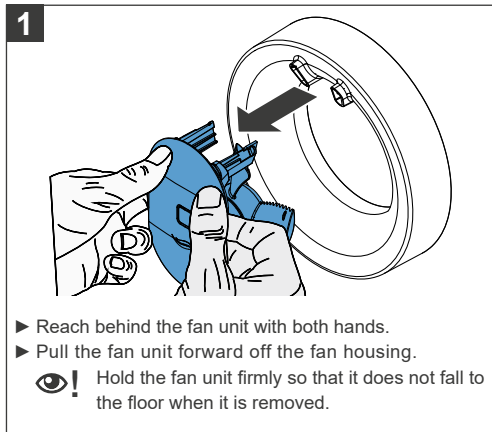



3

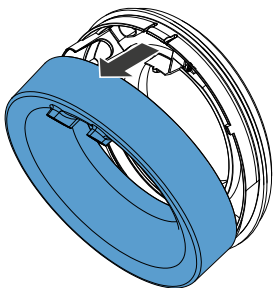

- ▶ Lift the cover of the fan housing from the top to the front.

4

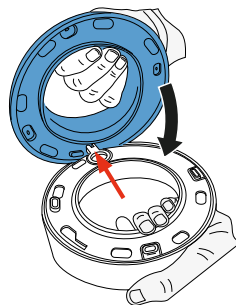

- ▶ Attach the rubber seal (from the accessory pack) to the back of the fan housing.
- 👁️! First carefully place the switch (red arrow) in the opening provided.

5

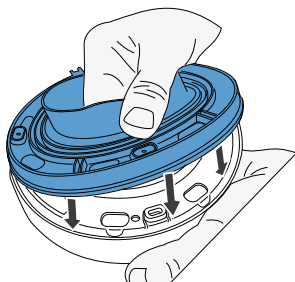

- ▶ Press the rubber seal firmly onto the base plate of the fan housing.
- 👁️! Starting on the side of the integrated switch pressing down on the opposite side.

6

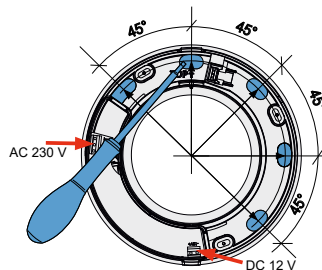

- ▶ Create a cable gland for the connection cable in the rubber seal at one of the 5 cable inlets with the aid of a suitable tool.
- 👁️! Place the cable gland near the respective terminal.

7

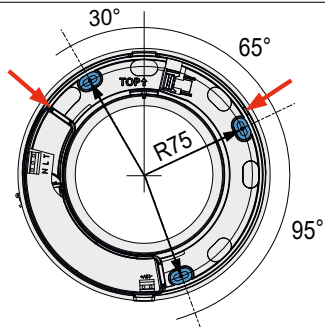

- ▶ Insert the fan housing into the wall sleeve from the inside.
  - 👁️! The lettering „TOP“ is facing upwards.
- ▶ Align the fan housing straight using a spirit level. To do this, place the spirit level at the support points of the fan housing (red arrows).
- ▶ Mark the 3 fastening holes (blue areas).
- ▶ Remove the housing from the wall sleeve and drill the holes.

8

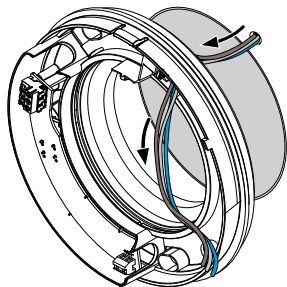

- ▶ Send the connection cable, AC 230 V, 50 Hz or DC 12 V, through the cable gland created in the rubber seal.

9

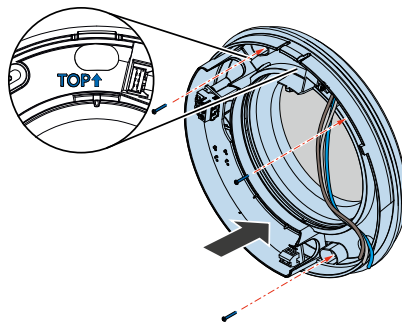

- ▶ Place the base plate, including the rubber seal, congruent with the mounting holes in the wall sleeve.
  - 👁️! The lettering TOP is legible and facing upwards.
- ▶ Screw the base plate of the fan housing to the inside wall.
  - 👁️! The rubber seal completely seals the extractor fan to the inner wall.



**NOTICE:** Laying the mains connection cable over the cover of the circuit board

will damage the circuit board and impair the function of the Pulsar!

- Do not lay mains cable AC 230V over the circuit board.

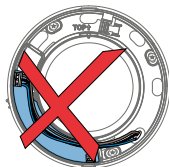

**NOTICE:** If 230 V AC and 12 V DC are connected at the same

time the Pulsar extractor fan will be damaged!

- **Never** connect the Pulsar to 230V AC and DC 12V **simultaneously**.

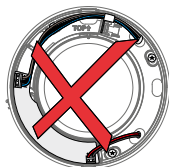

10

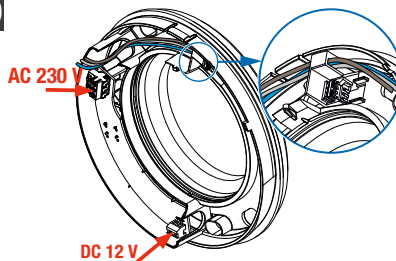

- ▶ Shorten the connection cable so that you can reach the connection terminal (red arrows).

**AC 230 V: 3-pole Connection Terminal**

**DC 12 V: 2-pole Connection Terminal**



Route the connection cable through the cable gland in the upper area to ensure correct installation of the fan unit.

11

**AC 230 V**

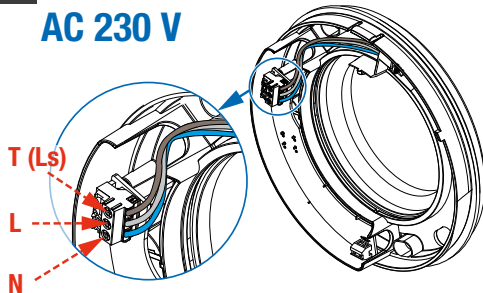

**DC 12 V**

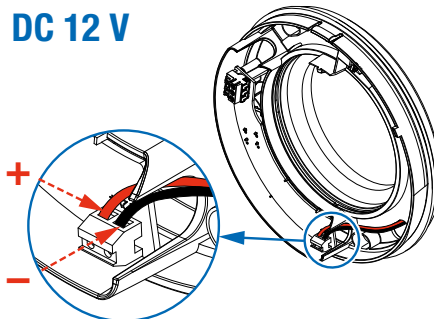

- ▶ Attach the shortened connection cable, according to the connection diagram, in the connection terminal of the base plate.



4: Terminal assignment, connection diagrams.

⇒ The Pulsar extractor fan is inserted and connected.

12

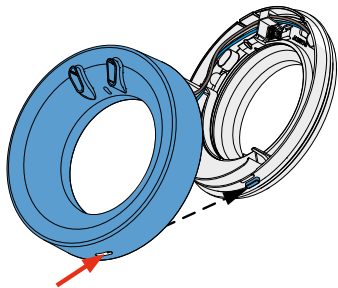

- ▶ Engage the hook on the lower side of the base plate in the hole (red arrow) on the lower side of the fan housing cover.

! The guides for the fan unit are located in the upper area.

13

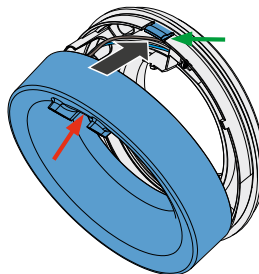

- ▶ Press the cover of the fan housing in the upper area onto the holder (green arrow) on the base plate of the fan housing.

! The locking button (red arrow) audibly engages between the guides.

14

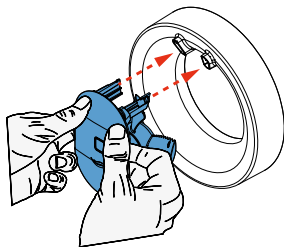

- ▶ Carefully insert the fan unit into the guides (red arrows) on the fan housing.

! Do not tilt the fan unit when inserting it so as not to damage the contacts.

⇒ An audible click confirms that the fan unit is correctly inserted.

15

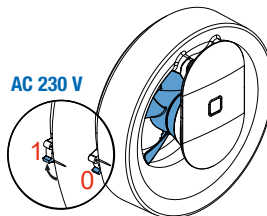

- ▶ Make sure that the fan can rotate freely before you switch it on.
- ▶ Switch on the power supply.
  - **DC 12 V:** When the power supply is switched on, the fan runs (with switch control, the external switch is used to switch on and off).
  - **AC 230 V:** Switch on the Pulsar. The switch is located on the left side of the housing. Push it upwards to position 1.

## 6 Commissioning

Commissioning is essentially limited to downloading, activating and setting up the app.



**NOTICE:** Only connect the Pulsar to your mobile device via the inVENTer Mobile App. Direct pairing via Bluetooth LE will lead to installation errors and the Pulsar must be reset.

Depending on the electrical connection of the Pulsar, different functions and settings are available within the app.

### Requirements for the functionality of the app:

- Mobile devices with Android or iOS operating system
- Bluetooth LE

The operating system and versions for the operating systems are updated continuously. You can find more information on our website: [www.inventer.eu](http://www.inventer.eu) and directly in the App Store (iOS) or Play Store (Android).

### Activating the inVENTer Mobile App

#### Step 1:

Download the inVENTer Mobile App for free in App Store (iOS) or Play Store (Android) in your mobile device.



#### Step 2:

Open the inVENTer Mobile App and press **START**.

#### Step 3:

To activate the App a PIN code is required. You will find it on the back of this documentation or on the right foot of the fan unit. Enter the PIN code or scan it with your mobile device.

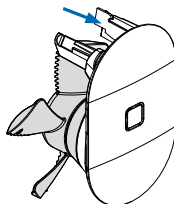

#### Step 4:

Follow the instructions in the setup menu.

⇒ You have activated the app and can configure your Pulsar.



**TIP:** Touch the “+” (blue arrow) in the start menu to add more inVENTer devices to the app.



## 7 Operation

### 7.1 Functional scope

The Pulsar extractor fan is operated and controlled via the inVENTer Mobile application software.

Without app control, only the factory settings are available.

The range of functions of your Pulsar are extended by the app with the following functions:

Setting of:

- Fan output (sensor-dependent); available in percent, revolutions per minute or litres per second
  - Humidity sensor sensitivity in three stages: Low – Medium – High; Limit values
  - Light sensor sensitivity in three stages: Low – Medium – High; Limit values
  - Run-on time in the range of 5 to 60 minutes
  - Switch-on delay between 5 and 10 minutes
  - Boost function
  - Intelligent pause function:
    - 1 time per day you can run your Pulsar for a freely selected period of time either OFF (only possible if no continuous ventilation is set) or at minimum power (continuous ventilation).
  - Interval operation:
    - If interval operation is activated, Pulsar runs once every 12 hours for 30, 60 or 90 minutes at maximum speed.
- Note:** The sensors are switched with priority. If the Pulsar has been activated by sensors in the meantime, the interval is shifted backwards accordingly.
- Continuous ventilation
  - Temperature settings in the range from 15 to 35 °C when used as an overflow fan

One Pulsar can be installed up on several mobile devices.

The following requirements must be met:

- The Pulsar must be within range of the mobile terminal (max. 10 m distance).
- The Bluetooth LE connection must be activated.
- The Pulsar must be displayed as active on the mobile end device.
- The Pulsar can only be operated with one mobile end device at a time. Simultaneous operation of the same Pulsar from several mobile end devices is not possible. The operation is then carried out by the device that first established a connection.

Here you can find out more about all the possibilities that inVENTer Mobile offers and can download the app directly:



## 7.2 LED display

There is an LED on the fan unit. It indicates various states of the extractor fan. The LED only lights up in the following cases:

### Illumination of the blue or white LED:

- There is an active Bluetooth connection to a mobile terminal.  
The blue or white LED must light up when you want to operate or configure the Pulsar extractor fan.

### Illumination of the red LED:

- Fault indication: The LED indicates a power supply failure when the intelligent pause function is set up.
- Resetting is possible by synchronising the app with the Pulsar extractor fan.

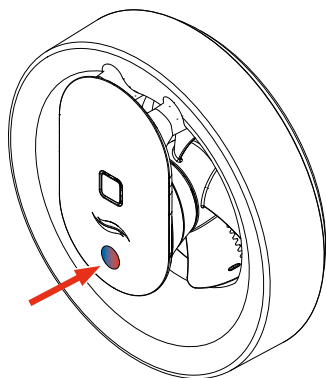

## 8 Cleaning and care



**CAUTION: Rotating parts on the fan cause injuries.**

- Before working on electrical equipment, disconnect all affected equipment from the power supply.



**CAUTION: Cleaning by children and persons with limited abilities can lead to injury to body parts and/or malfunction of the ventilation system!**

- Do not allow all cleaning and maintenance of the ventilation system to be carried out by children and persons who, due to their physical, sensory or mental abilities, inexperience or lack of knowledge, are not safely able to do so.

The Pulsar is almost maintenance-free. The cleaning and maintenance work can be carried out by the user after a brief introduction.

The measures and intervals listed here are recommendations by inVENTer GmbH to maintain the function and performance of your Pulsar. Depending on your needs and/or air quality, your personal cleaning schedule may differ from these recommendations.

Time span	Assembly part	Maintenance task
Monthly	Fan housing	Clean the surface with a damp cloth.
Semiannual	Fan unit	 24

### Cleaning agents:

**NOTICE:** The Pulsar has a plastic surface that is sensitive to scratches. Do not use cleaning agents containing sand, soda, acid or chlorine to avoid damaging the surface.

Commercial liquid soap in warm water can be used for cleaning.

### Procedure:

- ▶ Disconnect the power supply.
  - AC 230 V: Disconnect the connection at the switch of the Pulsar. The switch is located on the left side of the fan housing. Push it down to the 0 position.
  - DC 12 V: Interrupt the power supply at the mains fuse or at the external switch.

1

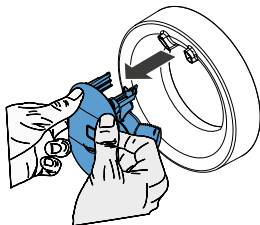

- ▶ Reach behind the fan unit with both hands.
  - ▶ Remove the fan unit from the fan housing by pulling it forwards.
- Eye!** Hold the fan unit firmly so that it does not fall to the floor after removal.

2



**NOTICE:** The fan must not be sprayed or immersed in water.

- ▶ Clean the wall sleeve, the fan housing and the fan unit with a damp cloth.
- Eye!** The fan is cleaned directly at the fan unit, it must not be dismantled.

3

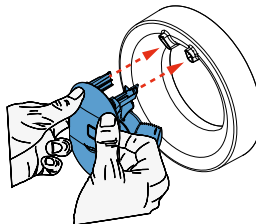

- ▶ Carefully insert the fan unit into the guides (red arrows) on the fan housing.
- Eye!** Do not tilt the fan unit when inserting it so as not to damage the contacts.
- ⇒ An audible click confirms that the fan unit is correctly inserted.



## 9 Technical Data

### Pulsar extractor fan

Feature	Value
Protection Class	II
Protection Type	IP44
Input voltage	AC 230 V or DC 12 V
Extract air flow (free-blowing) [m <sup>3</sup> /h]	110
Power consumption [W]	4
Sound emission (evaluated) [dB(A)]	17 – 20
Ambient temperature [°C]	5 – 50
Supply air	Without aggressive gases, dusts and oils
Diameter x Depth [mm]	177 x 81

### Flush-mounted power supply unit NT16

Feature	Value
Protection Class	II
Protection	IP20
Input voltage [V AC, Hz]	230, 50
Output voltage [V DC]	12
Power consumption [W]	12
Operating temperature [°C]	5 – 50
Diameter x Depth [mm]	54 x 32

### Air flow characteristic curve Pulsar

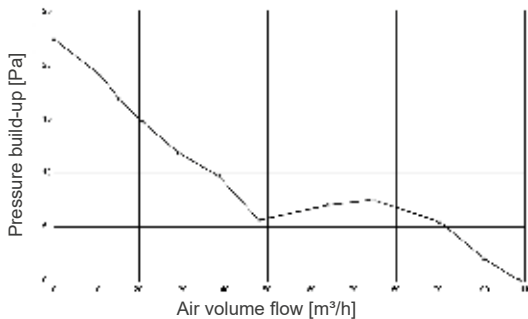

## 10 Scope of supply

Component	Order number
Pulsar incl. rubber seal (packed separately)	3002-0270

## 12 Service

### Complaints

Check the delivery for completeness and transport damage upon receipt using the delivery note. Report missing items immediately, and at the latest within 14 days to your supplier, distributor or factory representative.

### Accessories and spare parts

To order components for your ventilation unit, contact your factory representative or our service staff.

### Technical customer service

For technical advice, please contact our technical service staff.



+49 (0) 36427 211-0



info@inventer.de



+49 (0) 36427 211-13



www.inventer.eu

## 11 Accessories

Component	Order number
aV100 wall installation set	1001-0159
NT16 Flush-mounted PSU	1003-0094
Flush-mounted box 60x66	3002-0244
Cavity box 61x68	1003-0084

### Disposal

Dispose of the product in accordance with the applicable national regulations.



The products described in this documentation are largely recyclable because of their low-pollutant processing.

Contact a disposal company for electronic equipment for environmentally friendly recycling and disposal of your old system. Also dispose of the packaging correctly.

The disassembly necessary for disposal is carried out in reverse assembly order.

## 13 Warranty and Guarantee

### Warranty

Outside Germany, the national warranty regulations of the country in which the system is sold apply. Please contact the distributor in your home country.

The warranty covers all defects that were present at the time of purchase. Failure to observe the intended use will invalidate all warranty claims.

### Manufacturer guarantee

inVENTer GmbH provides a five-year warranty on the Pulsar extractor fan. This covers premature product wear. Information on the warranty conditions can be found at [www.inventer.eu/guarantee](http://www.inventer.eu/guarantee).

### Warranty and guarantee claims

In the event of a warranty or guarantee claim, contact the distributor or factory representative responsible for you. In any case, send the complete unit back to the manufacturer. The warranty claim is an additional offer by the manufacturer and does not affect applicable law in any way.



---

**PIN code / serial number**

Important! To activate the inVENTer Mobile app, enter the PIN code or scan it with your phone. You can also find your specific PIN code on the right foot of the fan unit.

---

inVENTer GmbH  
Ortsstraße 4a  
D-07751 Löberschütz  
[www.inventer.eu](http://www.inventer.eu)

Subject to modifications.  
No liability for printing errors.

**Artikel number: 5010-0004**  
009-500014-F  
**Version: 3.1 – 05/2022**

