



# inVENTer

Operation instructions

## sMove



## Control unit



# Trademarks, copyrights and industrial property rights

inVENTer® is a protected trademark of inVENTer GmbH.

The copyright to this document remains with the manufacturer.

Rights to all content and images: © inVENTer GmbH 2023.

All trademarks used in this document are the property of their respective manufacturers and are hereby acknowledged.

## Disclaimer

This documentation represents a translation of the original German operation instructions. Access to the operation instructions shall be passed on to third parties when the system is handed over. The contents of this documentation have been checked for conformity with the hardware and software described. Nevertheless, deviations cannot be excluded, so that no guarantee can be given for complete conformity.

This documentation describes the functionality of the standard range. For reasons of clarity, the documentation does not contain all detailed information on all types of the product and cannot take into account every conceivable case of commissioning, operation, cleaning and care.

The illustrations in this documentation may differ slightly from the design of the product you have purchased. The function remains the same despite the difference in detail.

This documentation is updated regularly. Necessary corrections and appropriate supplements are always included in subsequent editions. You can also find the latest version at [www.inventer.eu/downloads](http://www.inventer.eu/downloads).

## Company Information

Publisher:

inVENTer GmbH  
Ortsstraße 4a  
D-07751 Löberschütz  
Germany

Telefon: +49 (0) 36427 211-0  
Fax: +49 (0) 36427 211-113  
E-Mail: [info@inventer.de](mailto:info@inventer.de)  
Web: [www.inventer.eu](http://www.inventer.eu)

CEO: Annett Wettig  
VAT ID number: DE 815494982  
Jena District Court HRB 510380

## Table of contents

<b>1</b>	<b>User and Safety instructions</b> .....	<b>4</b>
1.1	User information.....	4
1.2	Safety instructions.....	4
<b>2</b>	<b>System overview: Controller sMove</b> .....	<b>6</b>
2.1	Construction.....	7
2.2	Functions.....	7
<b>3</b>	<b>Operation</b> .....	<b>10</b>
3.1	General handling.....	10
3.2	Initial commissioning.....	12
3.3	Setting heat recovery and ventilation mode.....	13
3.4	Activating/deactivating the pause function.....	14
3.5	Setting operating mode OFF (standard version only).....	15
3.6	Setting ventilation intensity.....	16
3.7	Confirming filter change.....	17
3.8	Viewing operating hours.....	18
<b>4</b>	<b>Cleaning and care</b> .....	<b>19</b>
<b>5</b>	<b>Accessories and spare parts</b> .....	<b>20</b>
<b>6</b>	<b>Troubleshooting and disposal</b> .....	<b>21</b>
<b>7</b>	<b>Warranty and guarantee</b> .....	<b>22</b>
<b>8</b>	<b>Service</b> .....	<b>22</b>

# 1 User and Safety instructions

Thank you for purchasing this high quality product from inVENTer!

This section provides an overview of the basic safety precautions for safe and proper operation of your controlling unit.

## 1.1 User information

### Safety and warning instructions

The safety and warning instructions in these installation instructions have a uniform structure and are marked with a symbol on the left side of the instruction. A signal word in front of the text also indicates the hazard level. If several hazard levels occur, the safety note for the highest level is always used.

The safety instructions and warnings contain the following information:



**SIGNAL WORD: Type and origin of the hazard.** Possible consequences of the danger!

- Measures to avoid hazard.

The signal word indicates the severity of the potential hazard unless the preventive measures are taken:



**WARNING** means: Possible danger of serious injury or death.



**CAUTION** means: Direct danger or minor/significant injury.



**NOTICE** means: Direct or possible risk of property damage due to an adverse event/state.

If you see these signs, follow the measures described to avoid possible danger and damage.

### Other symbols used in this documentation

In addition to the safety and warning instructions, the following symbols are used:



A **TIP** symbol indicates practical and useful tips for handling your control unit.



All illustrations show the inner wall.



**Action required:** This prompts the user to perform a specific action.



**Check results:** Requires user to check results of the action performed.



**Actions focus:** To be taken into account in the corresponding assembly step.

## 1.2 Safety instructions

The operating instructions are part of your controlling unit and must be available at all times (see [www.inventer.eu/downloads](http://www.inventer.eu/downloads)). The information on access to the operation instructions shall be passed on to third parties when the system is handed over.

Be sure to read through the operation instructions carefully before carrying out any work on the unit/system and observe all the notices in this chapter.

In addition, observe the safety instructions that precede the notices described. Failure to observe the safety instructions may result in personal injury and/or damage to property.

### Intended use

The sMove controller (also referred to as "controller" or "sMove" in the following text) is only to be used to control the decentralised iV ventilation devices with heat recovery from inVENTer GmbH.

In detail, the following are to be used:

- The sMove controller for controlling the inVENTer ventilation devices with heat recovery included in the system.
- The sensor system coupled with the controller (HYG18 hygrostat, HYG12 hygrostat, CS1 CO<sub>2</sub> sensor or pressure monitor) to supply temperature, humidity and CO<sub>2</sub> values to the sMove controller, which in turn uses them to control the inVENTer ventilation devices with heat recovery.

### Requirements for the intended use

- Only use the device/system in accordance with the applications described in this documentation and only in conjunction with the components recommended and approved by inVENTer GmbH and specified in this documentation.  
Modifications or conversions to the device/system are not permitted.
- Your ventilation device/system is exclusively designed for use in ambient temperatures between -20 and 50°C.
- Faultless and safe operation of the device/system requires proper transport, storage and assembly as well as careful maintenance.
- These operating instructions are only valid together with and supplement the operating instructions of the corresponding ventilation device with heat recovery.  
All legal notices listed in the respective operating instructions also apply without restriction to this document.



- **CAUTION:** The sMove controller must not be operated and cleaned by children and/or persons who, due to their physical, sensory or mental abilities, inexperience or lack of knowledge, are not safely able to do so, unless they are supervised by a person responsible for their safety or have been instructed by him/her on how to operate the system. Young children must be supervised so that they do not play with the system's equipment.



- **NOTICE:** The device has plastic surfaces that are sensitive to scratches. Do not touch components with oily and/or dirty hands. Avoid contact with sharp or pointed objects e.i Rings.

Use contrary to the intended purpose leads to the exclusion of any liability claims.

## Improper use

The sMove controller is intended exclusively for controlling the ventilation devices designated in the intended use. Any other use is expressly prohibited.

## 2 System overview Controller sMove

The sMove controller is an electronic control unit for controlling the inVENTer® ventilation devices with heat recovery. It is available in the variants s4 or s8, each in two versions (standard or flat).

The sMove controller enables the control of a maximum of the following ventilation devices:

Ventilation device series	Count <b>sMove s4</b>	Count <b>sMove s8</b>
with Xenion fan	4	8
with Xenion EFP/ Mini Xenion fan	2	4

It is characterised by its visually discreet, timeless and flat design as well as easy installation. The controller is operated by touching the capacitive buttons and the sliding controller on the control panel. With integrated light indicators (LEDs), the control panel also serves as a visual feedback/indicator for the user.

The sMove controller can be used as a basic controller or with additional connected sensors.

When used as a basic control, the operating mode of the ventilation devices as well as the setting of the air volume flow, either continuously or in 4 predefined stages, are possible.

An external interface allows the scope of functions to be extended:

- Demand-controlled ventilation via sensors (hygrostat, CO<sub>2</sub> sensor, VOC sensor<sup>1)</sup>[NO] ), or
- Integration of a safety device (e.g. pressure switch, [NC]) if the ventilation devices are operated simultaneously with firing places.
- Integration of the sMove controller into an existing home control system via an analogue input

## Components

- Mounting plate
- Control panel
- Switching power supply unit<sup>2)</sup>
- Mounting socket (optional)

## Models

The controller sMove is available in Standard and Flat variants.

In both versions, the external interface can be configured either as an external switching contact or as an analogue input.

<sup>1)</sup> VOC = volatile organic compounds

<sup>2)</sup>optionally as flush-mounted or top-hat rail switch-mode power supply unit

**Flat model**The controller switches the ventilation device to the “OFF” operating mode for 1 hour. The ventilation device then continues to operate in the previously saved operating mode and ventilation level. The use of the flat version is recommended in rooms that do not require to switch off the ventilation system to comply with moisture protection ventilation.

**Standard model:**The controller switches the ventilation device to the “OFF” operating mode completely. A ventilation stage must be selected for the ventilation device to operate again.

## 2.1 Construction

The controller sMove consist of a mounting plate for installation on the inner wall, and a control panel. The control panel contains the electronic components of the controller and the control panel cover (acrylic glass material)

In addition, a switching power supply unit (flush-mounted or control cabinet mounted) for power supply is included in the scope of delivery of the sMove controller.

The control panel on the surface of the controller serves as the operating and display surface.

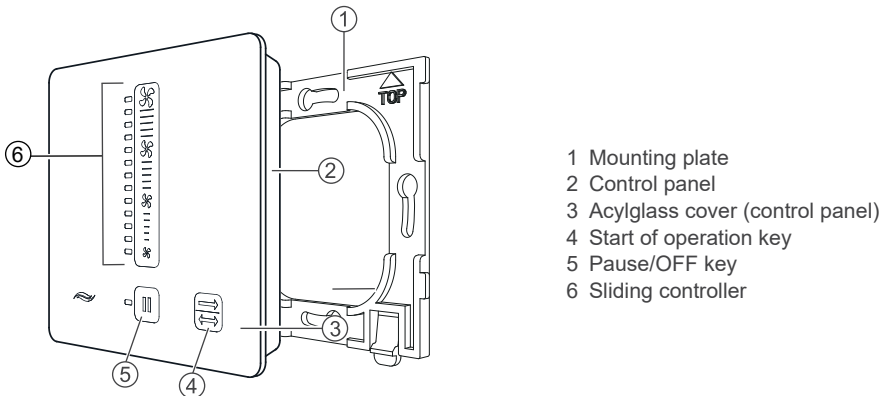

Figure 1: Front view of the controller sMove

- 1 Mounting plate
- 2 Control panel
- 3 Acylglass cover (control panel)
- 4 Start of operation key
- 5 Pause/OFF key
- 6 Sliding controller

## 2.2 Functions





The sMove controller is a control unit for the decentralised ventilation devices with heat recovery from inVENTer GmbH. If connected, the information transmitted to the controller by means of sensors is included in the control of the ventilation device.

### Controller sMove without closed interface

If the external interface is not connected, the operating mode and the intensity of the air volume flow can be set on the sMove controller.

The operating modes heat recovery and ventilation can be easily set by touching the operating mode button. The operating modes OFF or Pause function are selected by touching the Off/Pause button.

The intensity of the ventilation can be adjusted continuously in all operating modes by sliding the sliding controller or in 4 steps by touching the fan symbols on the slider. They serve as a guide.

Ventilation level.	Symbol	Air volume flow (%)
1		25
2		35
3		50
n.a.	LED 11	70
4		100

The changed setting is effective immediately, so that the setting can also be made according to purely acoustic noise compatibility.

A LED next to the respective button shows the selected operating mode. The position of the illuminated display on the left side of the sliding controller indicates the ventilation level currently set.

### Controller sMove with closed interface

The external interface is a bifunctional interface on the back of the control unit. It enables the connection of a sensor with potential-free switching contact (normally open/ normally closed contact) or use as an analogue input for integrating the ventilation system into an existing home control system.

With the connection of the external interface, the range of functions of your controller changes as follows:

#### A. Interface as external switching contact (sensor system)

The sensor used must have a potential-free relay contact as an output. The function of the interface is set via the jumper on the back of the control unit ( Installation Instructions [3.3](#): Jumper)

The connection of a pressure sensor is a necessity for spaces with interior air-dependent fireplaces. Contact a chimney sweep or building planner for this.

If the interface is used for a pressure sensor, the air pressure is continuously measured in the interior. As soon as this exceeds the safety-relevant limit value, the sensor reacts and switches off all ventilation devices connected to the control unit. The function remains active until the levels of air pressure are safe.

If the external interface is used to connect a hygrometer, the ambient humidity is continuously measured in the interior. If the external interface is used to connect a CO<sub>2</sub> sensor, the CO<sub>2</sub> content is continuously measured in the interior. The CO<sub>2</sub> sensor and hygrometer can be ordered as optional accessories.

If the external interface is used to connect a VOC<sup>1</sup> sensor, the composition of the air and the resulting air quality is continuously measured in the interior.



Sensor	Switch	Exceeding limit value	Undercutting limit value
Pressure sensor (4Pa)	NC contact	Change all ventilation devices connected to the controller to the OFF operating mode.	Change all ventilation devices connected to the controller to the originally set operating mode.
CO <sub>2</sub> sensor	N/O contact	Change all ventilation devices connected to the controller to ventilation operation mode, ventilation level 3.	
VOC <sup>1</sup> sensor			
Hygrostat			

### B. Interface as analogue input

If the interface is used as an analogue input, the ventilation system can be integrated into an existing home control system. For this purpose, depending on the desired function, a predefined DC voltage is set in the house control unit.

Depending on the control voltage, the ventilation and heat recovery operating modes are possible in ventilation stages 1 - 4, as well as switching off the connected ventilation devices (for control voltages, see installation instructions  3.3: Jumper).

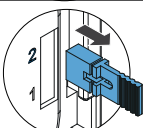
		N/O contact	NC contact	Sensor
Jumper position 2		Switch operated function		
	plugged-in	Normal operating mode	OFF (fire place function)	NC contact Safety set up (4 Pa)
	not plugged-in	Ventilation Ventilation level 3	Normal operating mode	N/O contact Hygrostat CO <sub>2</sub> VOC <sup>1)</sup>
		Interface as analogue input		

<sup>1)</sup> VOC = volatile organic compounds

## 3 Operation

### 3.1 General handling

The controller sMove consist of a mounting plate for installation on the inner wall, and a control panel.

The control panel contains the electronic components of the controller and the control panel cover (acrylic glass) The control panel serves as an input and display interface for the user.

#### Control panel

The control panel is located on the front of the control unit and also serves as a display surface. It consists of capacitive buttons and various luminous indicators. The operation is carried out by touching the various buttons (highlighted in grey in figure 2).

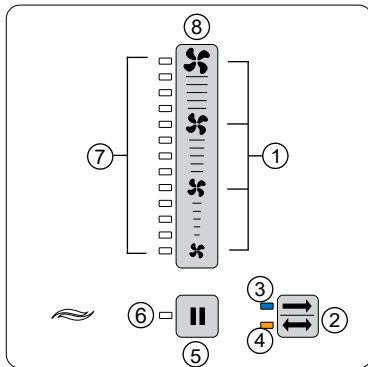

- 1 Markings ventilation level 1 – 4
- 2 Operation mode button.
- 3 Illuminated display ventilation mode (blue)
- 4 Illuminated display heat recovery operation mode (orange)
- 5 Pause/OFF button
- 6 Illuminated display Pause/OFF button
- 7 Illuminated display ventilation level LED 1-12: Display in Hours
- 8 Ventilation levels sliding controller.

Figure 2: Front view of the control panel controller sMove

#### Sliding controller

With a quick press of the fan symbols, one of the 4 preset ventilation levels can be selected. By touching the sliding controller for approx. 1 second, the ventilation level can be adjusted by continuously moving it. The position of the illuminated display on the left side of the sliding controller indicates the ventilation level currently set.

#### Operation mode button:





Press repeatedly to switch between heat recovery and ventilation modes. The illuminated display to the left of the operating mode button indicates the currently set operating mode.

## Pause/OFF button

-  By pressing briefly, the controller can be set to the pause function for either one, two, four or eight hours. In the standard model, pressing the button for approx. 5 seconds allows all ventilation devices connected to the controller to be switched off completely. Repeated pressing switches the connected ventilation devices on again. Completely switching off the ventilation devices is not possible in the flat model.

## Illuminated display

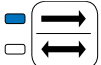
The sMove controller additionally serves as a display surface. To the left of the buttons there are LEDs that indicate the currently set parameters:

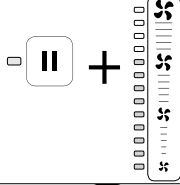
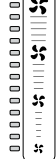
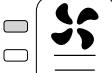
Position	LED	
	Display time	Definition
	duration	Heat recovery operating mode set Pause-function: after the pause, the controller switches the ventilation devices into heat recovery mode.
	alternating	Filter change display
	duration	Ventilation operation mode set Pause function: after the pause, the controller switches the ventilation devices into ventilation mode.
	alternating	Filter change display
	duration	OFF (standard version only)
	alternating	Operating mode pause, Display next to the sliding controller <ul style="list-style-type: none"> <li>• Pause function selection: Pause duration display</li> <li>• in pause function: Display of remaining pause time</li> </ul>
	Any illuminated display, permanent	Current ventilation level display
	alternating	Boost function is active

After 30 seconds without input, the illuminated displays switch off automatically. Touching any button reactivates the control panel.

The ventilation levels of the ventilation devices can be set in all operating modes.

Ventilation level.	Symbol	Air volume flow (%)
1	☸	25
2	☸☸	35
3	☸☸☸	50
4	☸☸☸☸	100

## 3.2 Initial commissioning

When the sMove controller is commissioned for the first time, the reversing fans of the ventilation devices start automatically in the lowest ventilation stage (25 %) in the heat recovery operating mode.

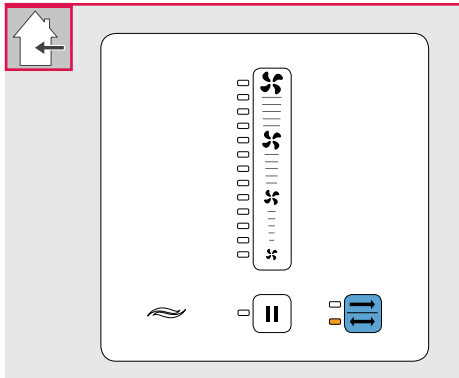

### Requirements:

The controller is connected to the power supply.

► Touch any button on the control panel.

- ⇒ The orange colored LED lights up.
- ⇒ The lowest LED to the left of the sliding controller lights up.
- ⇒ The controller is in heat recovery operating mode.
- ⇒ The ventilation level shows 25%.

The controller sMove saves internally the last chosen configuration of ventilation and operation mode. After the controller is switched off, for example in the event of a power interruption, the sMove controller switches on again in the last saved configuration of operating mode and ventilation level.

The previous configuration would be internally saved, as long as it was active for at least 1 hour.

### 3.3 Setting heat recovery / ventilation mode

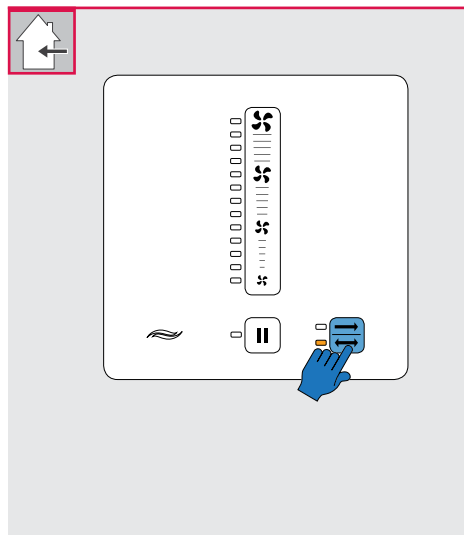

#### Setting heat recovery / ventilation mode



#### Requirements:

The controller is connected to the power supply.

- ▶ Press the  button until the corresponding (orange or blue) LED on the left side of the button lights up.

LED display		Operating modes
Orange		Heat recovery
Blue		Ventilation



**TIP:** By repeatedly pressing the button,  you can switch between the operating modes heat recovery and ventilation.

⇒ The operating mode is set/changed

#### Heat recovery operating mode



In this operating mode, the reversing fans of the ventilation devices operated in pairs change the direction of rotation every 70 seconds. The integrated thermal accumulator is charged with the thermal energy of the room air as it flows externally (extract air). After the direction of rotation has changed, the heat accumulator releases the stored heat energy to the incoming fresh air (supply air).

Set "heat recovery" as standard operating modes. During winter months, the outside temperature is colder than the temperature of the air inside. The incoming outdoor air is preheated as it flows through the ceramic heat accumulator before it enters the interior. It is also recommended on summer days, due to the higher outside temperature compared to the interior, the heat input during ventilation is significantly reduced.

#### Ventilation operation mode



In this operating mode, the reversing fans do not change the direction of rotation. In this operating mode, there is no heat recovery.

Select "Ventilation" to cool the room on summer nights or to quickly remove stale or humid room air.

### 3.4 Activating / deactivating the pause function

The reversing fan of the ventilation device is switched off for a set period of time. The ventilation devices do not work and there is no air exchange. Select the "Pause" function, for example, before going to bed.

Following the intermittent pause, the fans restart automatically at the selected ventilation level and in the previously set operating mode. Therefore, the inner cover must remain open.

#### Activating pause function

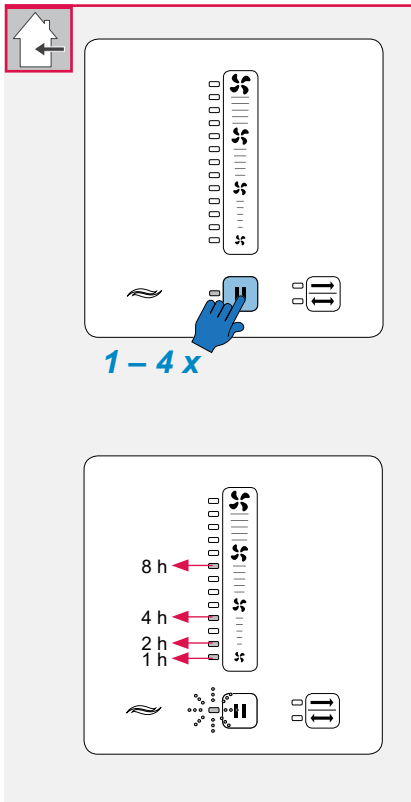

When setting the pause function, the controller first switches off the connected ventilation devices. The pause function can be set for one, two, four or eight hours. After the pause, the controller switches to the last stored operating mode and output level.



#### Requirements:

The controller is in heat recovery or ventilation operating mode.

- Press the button 

 	Pause duration
one time	1 hour
two times	2 hours
three times	4 hours
four times	8 hours

- ⇒ The Pause/Off light and the respective illumination display to the left of the slider flash alternately.
- ⇒ The pause function is set.
- ⇒ If the controller is in the pause function, the operating mode in which the ventilation devices restart after the end of the pause can be changed. To do this, activate the display by touching any button. Then press the  button until the LED lights up in the colour of the desired operating mode.



**TIP:** The pause can be overridden at any time by selecting another ventilation level.

## Pause remaining time display

If the sMove controller is in pause, the remaining time in which the controller is in pause can be viewed.

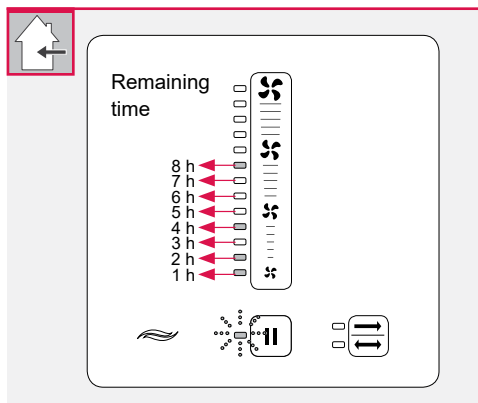

### Requirements:

The controller is set in pause function.

- ▶ Touch any button on the control panel.
- ⇒ The panel is active.
- ⇒ The LED flashes alternately (Fig. left).



**TIP:** In the standard model, the controller switches to OFF mode when the button  is pressed for longer than 5 seconds. The LED lights up continuously.

## 3.5 Setting operating mode OFF (standard version only)

The reversing fan of the ventilation device is switched off permanently. The ventilation devices do not work and there is no air exchange.



**TIP:** Completely switching off the ventilation devices is not possible in the flat model.

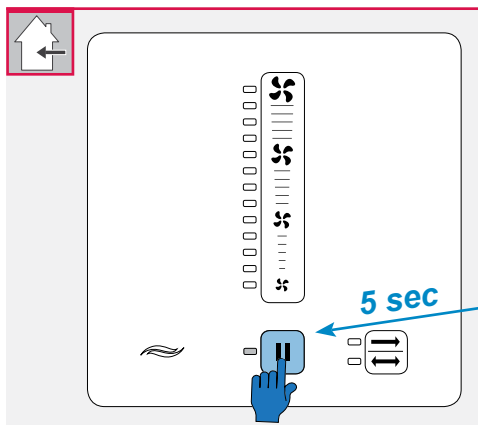

### Requirements:

The controller is in heat recovery or ventilation operating mode.

- ▶ Press the button  longer than 5 seconds.
- ⇒ The LED Pause/OFF lights up continuously.

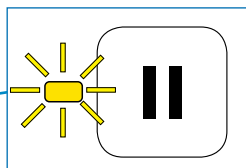

- ⇒ You have switched off the controller.

### 3.6 Continuously adjustable ventilation

The intensity of the ventilation can be adjusted continuously in all operating modes by sliding the sliding controller or in 4 steps by touching the fan symbols on the slider. The fan symbols on the sliding controller mark the ventilation level. They serve as a guide.

The changed setting is effective immediately, so that the setting can also be made according to purely acoustic noise compatibility.

#### Adjust ventilation using predefined levels

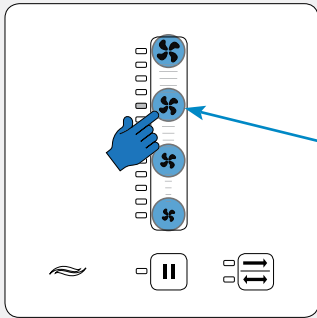

#### Requirements:

- The controller is in heat recovery or ventilation operating mode.

- ▶ Touch the button with the symbol of the desired ventilation level, e.g. level 3:

- Fan-output 100% (level 4)
- Fan-output 50% (level 3)
- Fan-output 35% (level 2)
- Fan-output 25% (level 1)

- ⇒ The LED to the left of the selected fan symbol lights up.

#### Continuously adjustable ventilation

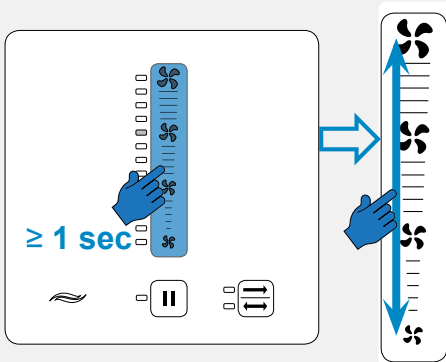

#### Requirements:

- The controller is in heat recovery or ventilation operating mode.

- ▶ Place your finger on the sliding controller for approx. 1 second.

- ⇒ The sliding controller is active.

- ▶ Move the finger on the sliding controller to the desired ventilation level.

- ⇒ The LED to the left of the sliding controller lights up.

- ⇒ The ventilation level is set.



## Setting Boost function

For quick removal of humidity or odour load peaks, the controller can be set manually to the maximum ventilation level. In boost function, the output of the reversing fans increases to 100% for 15 minutes. The operating mode is maintained.

Afterwards, the power is reduced to the original level.

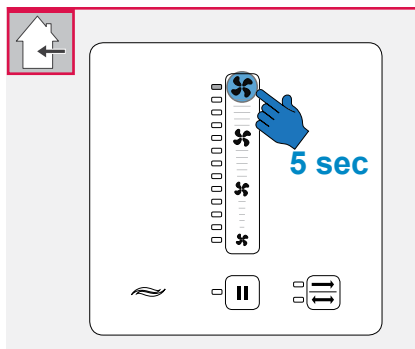

### Requirements:

The controller is in heat recovery or ventilation operating mode.

▶ Press the button  longer than 5 seconds.

⇒ The top LED to the left of the sliding controller lights up white.

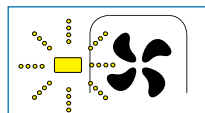

⇒ The controller is set in Boost function.

## 3.7 Confirming filter change

After 180 days, the necessary filter change is indicated by a continuous flashing of an LED indicator next to the operating mode button. The colour is defined by the current operating mode:

- Ventilation operating mode is active: blue LED flashes
- Heat recovery operating mode is active: orange LED flashes.

If the filter has been changed, it must be confirmed on the controller.

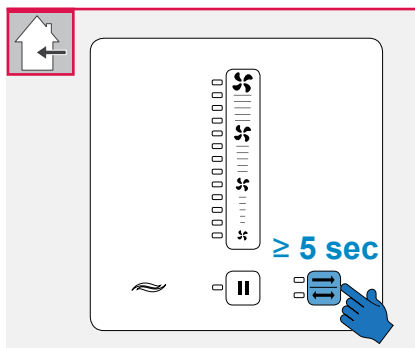
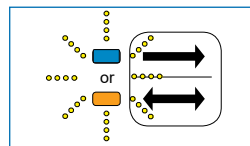

### Requirements:

The orange or blue LED flashes.

▶ Press the button  longer than 5 seconds.

⇒ The LED does not flash anymore.

⇒ The filter change interval is reset to 180 days.

⇒ The filter change has been confirmed.

### 3.8 Viewing operating hours

The sMove controller has an integrated operating hours counter. The output of the operating time is in days. The maximum period that can be displayed is 4,000 days. A day corresponds to a measuring period of 24 hours, within which there is no further division.

The operating time is displayed as a 4-digit number. Each digit, starting with the first digit, is displayed individually via the indicator light to the left of the sliding controller/pause button.

The LED to the left of the  button corresponds to the number 0.

The LED to the left of the sliding controller corresponds to the numbers 1 (below) to 9 (top)

When the number is displayed, the final value lights up permanently.

To simplify counting, a number of running lights equal to the final value moves towards the final value.

The displays go out between the individual digits.

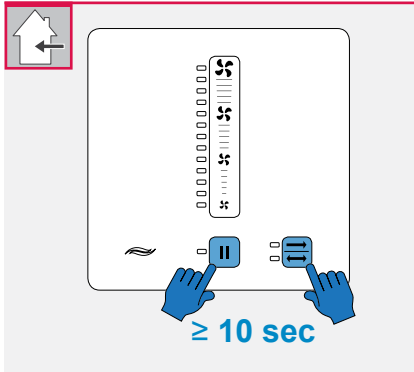
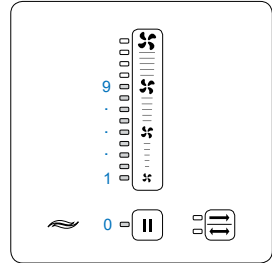

**Requirements:**

The controller is connected to the power supply.

- ▶ Press the  and  buttons simultaneously for 10 seconds until the indicator lights go out.
- ▶ Make a note of the digits displayed.
- ▶ Connect the digits to form a number:

- Number at position 1 = first digit displayed
- Number in position 2 = second digit displayed
- Number in position 3 = third digit displayed
- Number in position 4 = fourth digit displayed

⇒ The operating days of the controller have been retrieved.

**Example**

Position of the digit	Illuminated display	Number
Position 1	Left to the pause button.	0
Position 2	Final value: 4th LED left to the sliding controller 4 running lights move towards the end value	4
Position 3	left to the pause button.	0
Position 4	Final value: 7th LED left to the sliding controller 7 running lights move towards the end value	7

⇒ The controller is 0-4-0-7 (407) days in operation.

## 4 Cleaning and care



### CAUTION:

#### Cleaning by children and persons with limited abilities.

leads to injury to body parts and/or malfunction of the ventilation system!

- Do not allow any cleaning or maintenance work on the ventilation system to be carried out by children or persons who are not capable of doing so safely due to their physical, sensory or mental abilities, inexperience or lack of knowledge.

The controller sMove ist virtually maintenance free. The service work can be carried out by the user after a short instruction.



**TIP:** Disconnect the power supply for all cleaning and maintenance work.

### Cleaning supplies:



### NOTICE:

#### Due to the scratch-sensitive plastic surface of the controller

the surface may be damaged!

- Do not use cleaning agents containing sand, soda, acid or chlorine to avoid damaging the surface.

A commercially available washing-up liquid in warm water can be used for cleaning.

The following aids can be used for cleaning:

- Linth free, soft cloth.
- soft brush

### Service recommendations

The service measures and intervals listed here are recommendations by inVENTer GmbH to maintain the functionality and performance of your controller.

Depending on your needs, your personal plan may differ from these recommendations.

Time span	Assembly group	Maintenance measure
Monthly	Control panel sMove	Clean the acrylic glass cover and side surfaces with a damp cloth. Brush the ventilation slots free.

## 5 Accesories and spare parts

Contact your local distributor to order components for your ventilation system.

Component	Product Number
Control panel	
Control panel sMove	3002-0396
Sensors (optional)	
CO <sub>2</sub> sensor CS1	1004-0145
Hygrostat HYG18	1002-0044
Hygrostat HYG12	1002-0015
Switching power supply unit	
S-Power supply unit NT17-s4	3002-0274
S-Power supply unit NT17-s8 (for top-hat rail mounting)	3002-0275
UP-Power supply unit NT18-s4	3002-0318
UP-Power supply unit NT17-Mz/s8	3002-0267

## 6 Troubleshooting and disposal

### Troubleshooting

Fault	Possible cause	Remedy
Incorrect function with interface connected	Upper jumper incorrectly/ not plugged in.	<p>Check the upper jumper on the back of the control unit:</p> <ul style="list-style-type: none"> <li>plugged-in: OFF by NC contact (Pressure sensor)</li> <li>not plugged-in Ventilation operation mode, level 3 bei N/O contact (Hygrostat, CO<sub>2</sub> sensor)</li> </ul>
Fans without function	Pressure sensor connected as NO contact (e.g. replacement of control unit).	Conversion of the pressure sensor as a normally closed contact (changeover contact) or, if necessary, replacement with a pressure sensor with a normally closed contact.
Controller without function	Control unit incorrectly or not connected.	Check wiring.
	No contact.	Check cables. Ensure sufficient insulation (approx. 8.5 mm)
The LED do not light up.	Faulty controller.	Replace controller.
	No voltage is applied.	Check power supply.
Sliding controller defective		Replace controller.

If you cannot eliminate the fault, contact our technical customer service. Information as to how can be found in step 8: Service.

### Disassembly and disposal

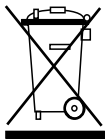

Disassemble the controller before disposal. Dispose of the product in accordance with the applicable national regulations. The products described in these operating instructions are largely recyclable due to their low-pollutant processing. Contact an electronics disposal company for environmentally sound recycling and disposal. Also dispose of the packaging correctly.

Product	Material	Disposal
Control panel casing	ABS	Plastics recycling
Control panel glass plate	Acryl glass	Residual waste
Circuit board / Switching power supply unit	Electronic parts	Collection point for electronic equipment

## 7 Warranty and guarantee

### Warranty

The warranty covers all defects that were present at the time of purchase. Observe the intended use in order to maintain the warranty claim.

Outside Germany, the national warranty regulations of the country in which the system is sold apply. Contact the dealer of your home country.

### Guarantee:

inVENTer GmbH gives a 5-year guarantee on all electronic components. This covers premature product wear.

### Warranty and guarantee claim

For information on the guarantee provisions, see [www.inventer.eu/garantie/guarantee](http://www.inventer.eu/garantie/guarantee).

In the event of a warranty or guarantee claim, contact the dealer or factory representative responsible for you.

In any case, send the complete unit back to the manufacturer.

The warranty claim is an additional offer by the manufacturer and does not affect applicable law in any way.

## 8 Service

### Complaints

Check the delivery for completeness and transport damage on receipt, using the delivery note.

Complain about missing items immediately, at the latest within 14 days, to your supplier, dealer or factory representative.

### Accessories and spare parts

To order components for your ventilation device, contact your dealer or factory representative.

### Technical customer service:

For technical advice, please contact our technical service staff:

 +49 (0) 36427 211-333

 [service@inventer.de](mailto:service@inventer.de)



inVENTer GmbH  
Ortsstraße 4a  
D-07751 Löberschütz  
www.inventer.eu

Subject to modifications  
No liability for printing errors

**Product Number 5012-0030**  
**Version: 1.0 – 10/2023**

